









Novo-Line®

	Page	No	
Bathroom fittings			
	Hook, Ø14 mm, rose Ø64 x 4 mm	173	2880
	Hook rack 315 x 64 x 4 mm, with 3 Ø14 mm hooks	174	2881
	Hook Ø8 mm, rose Ø40 x 3 mm	178	2980
	Hook rack 143 x 40 x 3 mm, with 2 Ø8 mm hooks	178	2981
	Hook rack 240 x 40 x 3 mm, with 3 Ø8 mm hooks	179	2982
	Hat and coat hook Ø8 mm, rose Ø65 x 3 mm	179	2983
	Toilet roll holder Ø14 mm	173	2876
	Toilet roll holder Ø8 mm	177	2976
	Spare toilet roll holder Ø25 mm	172	2875
	Spare toilet roll holder Ø8 mm	177	2975
	Toilet brush Ø98 x 255 mm	176	2970
	Mirror holder Ø40 x 12 mm	174	2924
	Shelf support 40 x 23 mm	175	2925
	Mirror shelf 75 x 130 x 560 mm, special	172	2825
	Soap Magnet 40 x 64 x 40 mm	175	2951
	Dispenser holder 40 x 64 x 40 mm	176	2952
	Soap dispenser 100 x 300 mm	182	2971
	Soap dispenser 100 x 300 mm, with elbow operation	183	2973
	Paper towel dispenser 300 x 300 mm	184	2974
	Paper towel dispenser 150 x 300 mm, special	184	2974.x1x
	Glove dispenser 150 x 300 mm, special	185	2990
Glove dispenser 300 x 300 mm, special	185	2990.x10	
	Waste bin 350 x 350 x 203 mm	180	2893
	Waste bin 292 x 246 x 160 mm	180	2898
	Waste bin 305 x 250 x 176 mm, with lid	181	2898.01
	Waste bin 300 x 300 mm	181	2978

no 2825



Special, made to order

Mirror shelf, 75x130x560 mm, drilled for 6 mm screws.

Available in satin stainless steel (AISI 304).

Supplied singly incl. washers and screws.

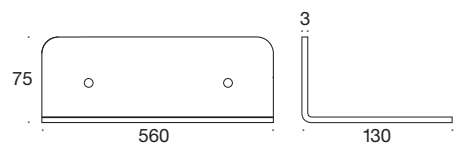

Stainless steel: 2825.00

no 2875



Spare toilet roll holder, $\varnothing 25 \times 143$ mm tube, rose $\varnothing 80 \times 3$ mm, drilled for wood screws.

Available in satin stainless steel (AISI 304).

Supplied singly incl. wood screws 4x40 mm.

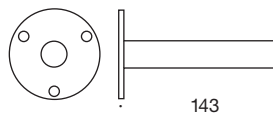

Stainless steel: 2875.00

no 2876



Toilet roll holder, $\varnothing 14$ mm, rose $\varnothing 50 \times 20$ mm, drilled for wood screws.

Available in satin stainless steel (AISI 304).

Supplied singly incl. wood screws 4x50 mm.

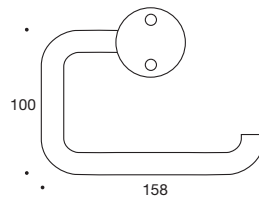

Stainless steel: 2876.00

no 2880



Hook, $\varnothing 14$ mm, rose $\varnothing 65 \times 4$ mm, drilled for wood screws.

Available in satin stainless steel (AISI 304).

Supplied singly incl. wood screws 4x40 mm.

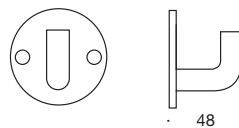

Stainless steel: 2880.00

no 2881



3-hook rack, $\varnothing 14$ mm hooks, with backplate 315x64 mm.
Drilled for wood screws.

Available in satin stainless steel (AISI 304).

Supplied singly incl. wood screws 4x40 mm.

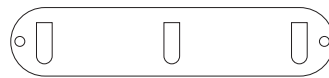

48

Stainless steel: 2881.00

no 2924



Mirror holder, $\varnothing 40 \times 12$ mm, drilled for wood screw.

Available in satin stainless steel (AISI 316).

Supplied singly incl. wood screws 3,5x50 mm.

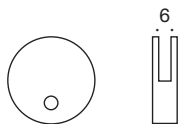

Stainless steel: 2924.00

no 2925



Shelf support, 40x23 mm, for 3-6 mm shelf, drilled for wood screws.

Available in satin stainless steel (AISI 316).

Supplied singly incl. wood screws 3,5x50 mm.

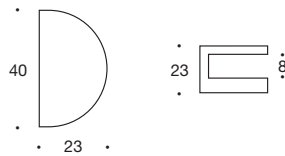

Stainless steel: 2925.00

no 2951



Soap magnet, 3 mm stainless steel, drilled for wood screws.

Available in satin stainless steel (AISI 316).

Supplied singly incl. wood screws 3,5x35 mm.

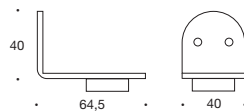

Stainless steel: 2951.00

no 2952



Dispenser holder, 3 mm stainless steel, suits most common soap/cream dispensers, incl. plastic adaptor, drilled for wood screws.

Available in satin stainless steel (AISI 316).

Supplied singly incl. wood screws 3,5x35 mm.

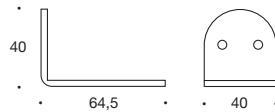

Stainless steel: 2952.00

no 2970



Toilet brush for wall mounting. Wall fittings $\varnothing 8$ mm hanger on backplate 40x143 mm.

Supplied with toilet brush holder in porcelain $\varnothing 98 \times 255$ mm and black brush head in nylon.

Available in satin stainless steel (AISI 316).

Supplied singly incl. wood screws 4x50 mm.

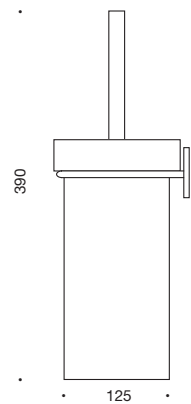

Stainless steel: 2970.00

Replacement brush head: 88.571
Porcelain brush holder: 2990.02

no 2975

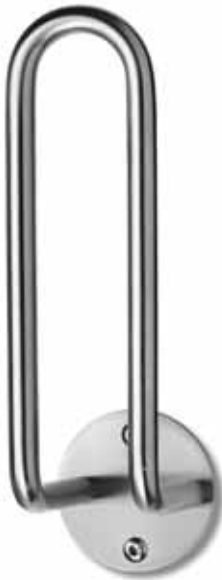

Spare toilet roll holder, $\varnothing 8$ mm, rose $\varnothing 45 \times 3$ mm. Drilled for wood screws.

Available in satin stainless steel (AISI 316).

Supplied singly incl. wood screws 3,5x50 mm.

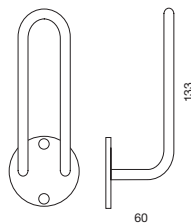

Stainless steel: 2975.00

no 2976



Toilet roll holder, $\varnothing 8$ mm, rose $\varnothing 40 \times 13$ mm, drilled for wood screws.

Available in satin stainless steel (AISI 316).

Supplied singly incl. wood screws 3,5x50 mm.

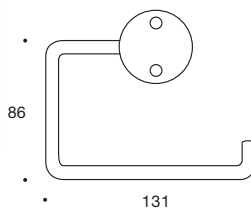

Stainless steel: 2976.00

no 2980



Hook, ø8 mm. Rose ø40x3 mm, drilled for wood screws.

Available in satin stainless steel (AISI 316).

Supplied singly incl. wood screws 3,5x35 mm.

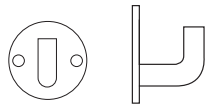

Stainless steel: 2980.00

no 2981



2-hook rack, ø8 mm hooks, with backplate 143x40 mm.
Drilled for wood screws.

Available in satin stainless steel (AISI 316).

Supplied singly incl. wood screws 3,5x35 mm.

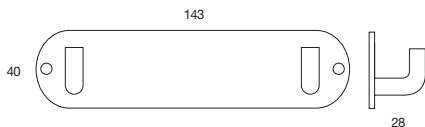

Stainless steel: 2981.00

no 2982



3-hook rack, $\varnothing 8$ mm hooks, with backplate 240x40 mm.
Drilled for wood screws.

Available in satin stainless steel (AISI 316).

Supplied singly incl. wood screws 3,5x35 mm.

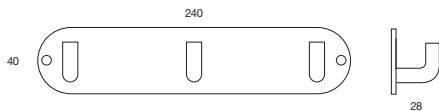

Stainless steel: 2982.00

no 2983



Hat and coat hook, $\varnothing 8$ mm, rose $\varnothing 65 \times 3$ mm, drilled for wood screws.

Available in satin stainless steel (AISI 316).

Supplied singly incl. wood screws 3,5x35 mm.

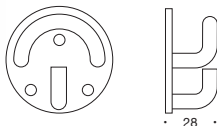

Stainless steel: 2983.00

no 2893



Waste bin, 350x350x203 mm, detachable. Volume = 23 litres.

Available in satin stainless steel (AISI 304).

Supplied singly excl. screws.

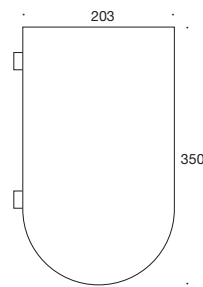

Stainless steel: 2993.00

no 2898



Waste bin, 292x246x160 mm, detachable. Volume = 8 litres.

Available in satin stainless steel (AISI 304).

Supplied singly excl. screws.

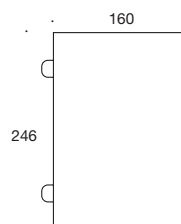

Stainless steel: 2898.00

no 2898.01



Waste bin with lid, 305x250x176 mm, detachable.
Volume = 8 litres.

Available in satin stainless steel (AISI 304).

Supplied singly excl. screws.

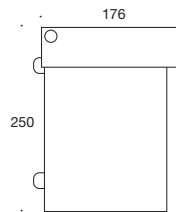

Stainless steel: 2898.01

no 2978



Waste bin, 300x300x190 mm, detachable. Volume: 17 litres.

Available in satin stainless steel (AISI 316). Also available with painted finish.

Supplied singly incl. plug and screws.

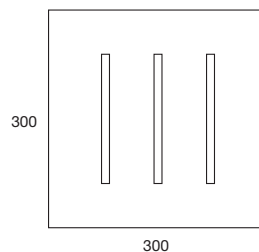

Stainless steel: 2978.00

no 2971



Soap dispenser, 100x110x300 mm, manual. Supplied with mechanism for common types of liquid soap or for standard refill (1 litre). Supplied with or without lock.

Available in satin stainless steel (AISI 316). Also available with painted finish.

Supplied singly incl. plug and screws.

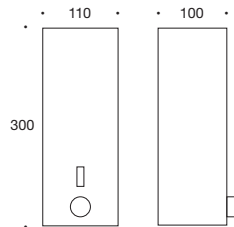

Stainless steel, for common types of liquid soap

Stainless steel, for common types of liquid soap , with lock

Stainless steel, for standard refill (1,0 l)

Stainless steel, for standard refill (1,0 l), with lock

2971.x10

2971.x11

2971.x20

2971.x21

Colour code is defined by replacing X with the correct no of colour.

0 = Satin stainless steel,

1 = Grey, 4 = White.

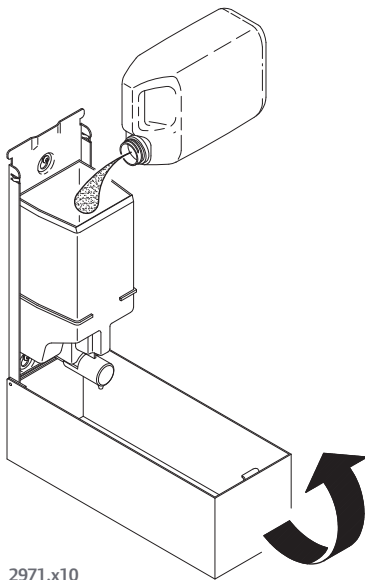

2971.x10

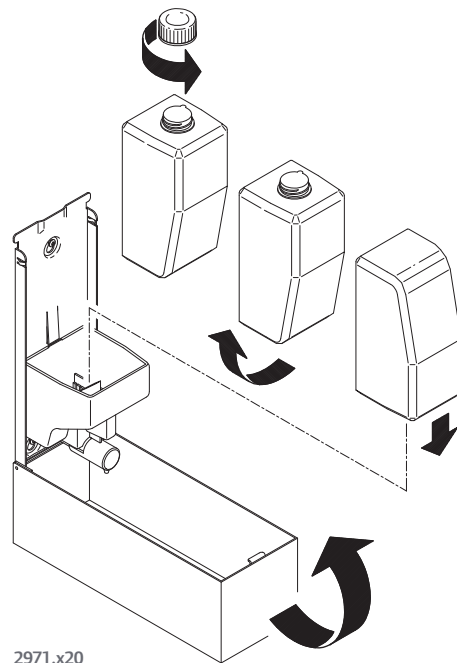

2971.x20

no 2973



Hospital soap dispenser, 100x110x300 mm, manual, with elbow operation. For standard sterile 1.0 litre bottles with non-return pump. Supplied with or without lock.

The dispenser is available with an indication of contents. The indication is shown as a „colour dot“ on the dispenser arm.

Available in satin stainless steel (AISI 316). Also available with painted finish.

Supplied singly incl. plug and screws.

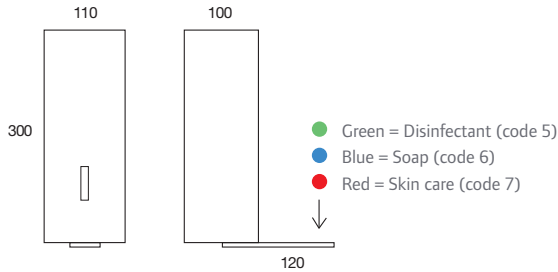

- | | |
|---|----------|
| Stainless steel, without colour indication of contents | 2973.x00 |
| Stainless steel, without colour indication of contents, with lock | 2973.x01 |
| Stainless steel, green indication mark | 2973.x50 |
| Stainless steel, green indication mark, with lock | 2973.x51 |
| Stainless steel, blue indication mark | 2973.x60 |
| Stainless steel, blue indication mark, with lock | 2973.x61 |
| Stainless steel, red indication mark | 2973.x70 |
| Stainless steel, red indication mark, with lock | 2973.x71 |

Colour code is defined by replacing X with the correct no of colour.
0 = Satin stainless steel, 1 = Grey, 4 = White

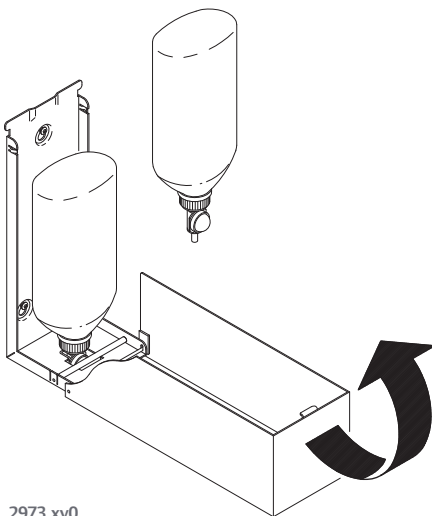

2973.xy0

no 2974



Paper towel dispenser, 300x300x100 mm. Suited to zig zag folded and C folded paper in the range 80x125/90x250 mm. Supplied with or without lock.

Available in satin stainless steel (AISI 316). Also available with painted finish.

Supplied singly incl. plug and screws.

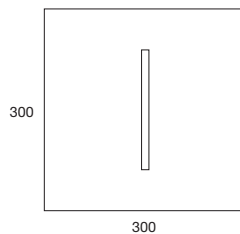

Stainless steel: **2974.x00**
Stainless steel, with lock : **2974.x01**

Colour code is defined by replacing X with the correct no of colour.
0 = Satin stainless steel, 1 = Grey, 4 = White

no 2974.x1x



Special, made to order

Paper towel dispenser, 150x300x100 mm. Suited to zig zag folded and C folded paper in the range 80x125/90x250 mm. Supplied with or without lock.

Available in satin stainless steel (AISI 316). Also available with painted finish.

Supplied singly incl. washers and screws.



Stainless steel: **2974.x10**
Stainless steel, with lock : **2974.x11**

Colour code is defined by replacing X with the correct no of colour.
0 = Satin stainless steel, 1 = Grey, 4 = White

no 2990



Special, made to order

Dispenser for gloves, 300x150x100 mm, detachable.

Available in satin stainless steel (AISI 316). Also available with painted finish.

Supplied singly incl. plug and screws.



Stainless steel: **2990.x00**

Colour code is defined by replacing X with the correct no of colour.

0 = Satin stainless steel, 1 = Grey, 4 = White

no 2990.x10



Special, made to order

Dispenser for gloves, „double“, 300x300x100 mm, detachable.

Available in satin stainless steel (AISI 316). Also available with painted finish.

Supplied singly incl. plug and screws.

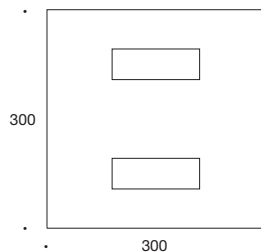

Stainless steel: **2990.x10**

Colour code is defined by replacing X with the correct no of colour.

0 = Satin stainless steel, 1 = Grey, 4 = White